

Reference: KROR204F115

EAN13: 8050997074234

**Product title:**

4 Holes - LARGE Round Ceiling Canopy Kit - Rose One System

**Product attributes:**

Decoration: Matt White, Matt Black, Marble Marquina, Marble Carrara, Concrete, Satin Brass Dibond, Satin Copper Dibond, Satin Steel Dibond, Wood, Anthracite, Mirror, Yellow mustard, Soft blue, Petrol, Soft Green

Ceiling Rose Colour: White, Black

**Product image:**

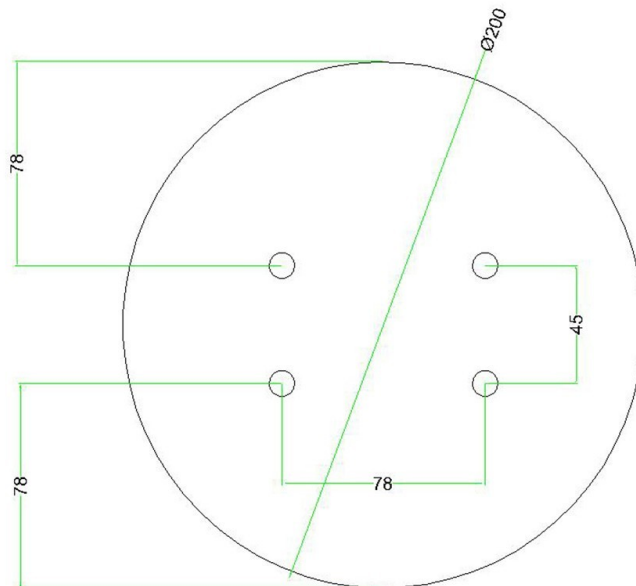

**Product price:**

\$34.60 tax included

**Product short description:**

This Rose One Canopy Kit comes with EVERYTHING you need to make your own 4 hole pendant light utilizing our LARGE round Rose One Canopy & Cover.

What sets this apart from our regular pendant light canopies is that this is a two part system with an extra deep ceiling canopy that allows for easier wiring of connections, as well as a wide cover over the canopy that allows you to create pendant lights, swag chandeliers, cluster lights and more with even greater impact.

This Rose One Canopy Kit includes the following: a LARGE Rose One Cover (7.87" diameter) with pre-drilled holes; a LARGE Extra Deep Rose One Canopy (4.7" diameter); cable clamp strain reliefs; and all brackets & mounting hardware.

Our Rose One Canopy Kits come in a wide variety of colors and designs. And you can choose from the whichever pre-drilled hole pattern works best for you OR purchase one of our Rose One Cover Un-drilled Blanks and you can create whatever pattern you like!

**Product description:****Technical data for LARGE Round Ceiling Canopy Kit - Rose One System**

- LARGE Extra Deep Rose One Ceiling Canopy
- Diameter: 4.7 inches
- Height: 1.38 inches
- Material: metal
- Bracket fasteners
- 4 Caps and 4 rubber grommets are included for side holes
  
- LARGE Rose One Cover
- Material: aluminum or dibond
- Diameter: 7.87 inches
- Hole diameters: 10 mm (3/8")
- Thickness: if aluminum 1 mm, if dibond 3 mm
- Clear plastic cable clamp strain reliefs included (1 per hole)

The Rose One System is Patent Pending

<https://youtu.be/P5N7h5tYtYc>

**Product features:**

Material: Metal

Material: Dibond

Material: Aluminium

**Product gallery:**

