

Reference: KROR203LF203  
EAN13: 8057730843034

**Product title:**

3 In-line Holes - LARGE Round Ceiling Canopy Kit - Rose One System - PROMO

**Product attributes:**

Decoration: Palette, Street Art, Pop-Corn, Orange, Blossom, Damasco, Mandala Varanasi, Tree Trunk

**Product image:**

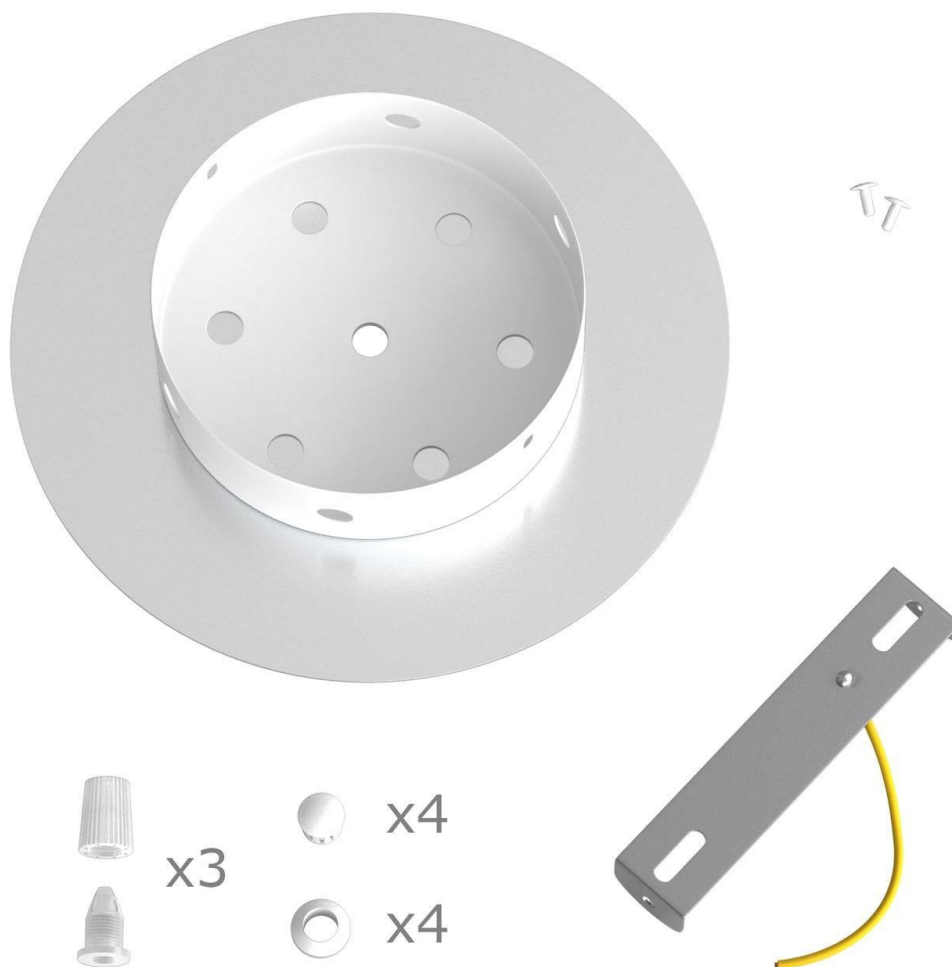

**Product price:**

\$23.40 tax included

**Product short description:**

This Rose One Canopy Kit comes with EVERYTHING you need to make your own 3 hole pendant light utilizing our LARGE round Rose One Canopy & Cover.

What sets this apart from our regular pendant light canopies is that this is a two part system with an extra deep ceiling canopy that allows for easier wiring of connections, as well as a wide cover over the canopy that allows you to create pendant lights, swag chandeliers, cluster lights and more with even greater impact.

This Rose One Canopy Kit includes the following: a LARGE Rose One Cover (7.87" diameter) with pre-drilled holes; a LARGE Extra Deep Rose One Canopy (4.7" diameter); cable clamp strain reliefs; and all brackets & mounting hardware.

Our Rose One Canopy Kits come in a wide variety of colors and designs. And you can choose from the whichever pre-drilled hole pattern works best for you OR purchase one of our Rose One Cover Un-drilled Blanks and you can create whatever pattern you like!

**Product description:****Technical data for LARGE Round Ceiling Canopy Kit - Rose One System**

- LARGE Extra Deep Rose One Ceiling Canopy
- Diameter: 4.7 inches
- Height: 1.38 inches
- Material: metal
- Bracket fasteners
- 4 Caps and 4 rubber grommets are included for side holes
  
- LARGE Rose One Cover
- Material: aluminum or dibond
- Diameter: 7.87 inches
- Hole diameters: 10 mm (3/8")
- Thickness: if aluminum 1 mm, if dibond 3 mm
- Clear plastic cable clamp strain reliefs included (1 per hole)

The Rose One System is Patent Pending

**Product features:**

Material: Metal  
Material: Dibond  
Material: Aluminium

Product gallery:

